

| REV. | ECN.NO. | APPD. |
|------|---------|-------|
| A | / | pcy |

- NOTES:
- MATERIAL:
 - Housing:thermoplastic plastics
 - terminals:Copper Alloy
Gold plated in contact area:
OR Gold Plated overall
 - Shell:Steel&Copper Alloy
Nickel/Tin Plated overall
 - ELECTRICAL CHARACTERISTICS:
 - Rating Current :1.5 Ampere
 - Rating Voltage :125 V Max
 - Contact Resistance:50 Milli ohms
 - Insulation Resistance:500 Mega ohms Min.
 - MECHANICAL CHARACTERISTICS:
 - Connector Mating force: 2.27kgf MAX
 - Durability:750Cycles.
 - ENVIRONMENT CHARACTERISTICS:
 - Operating temperature:-40°C to +85°C
 - Storage temperature:-10°C to +40°C

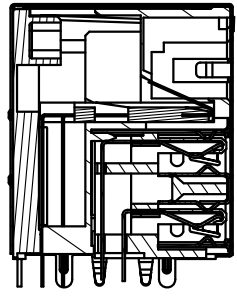

SECTION A-A

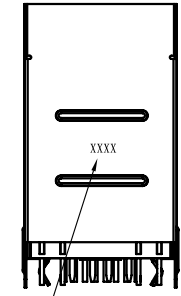
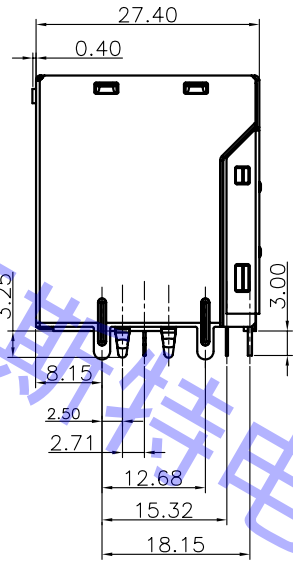
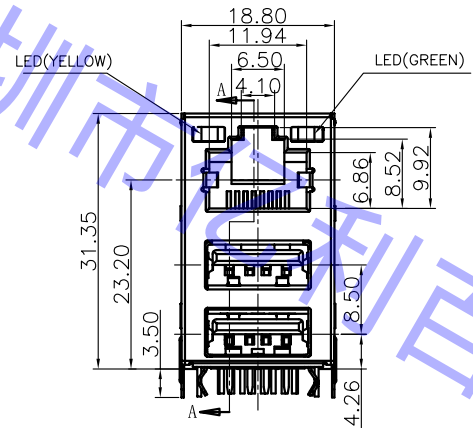
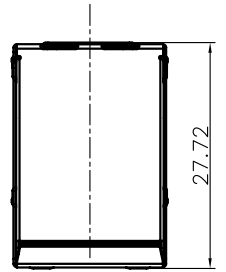
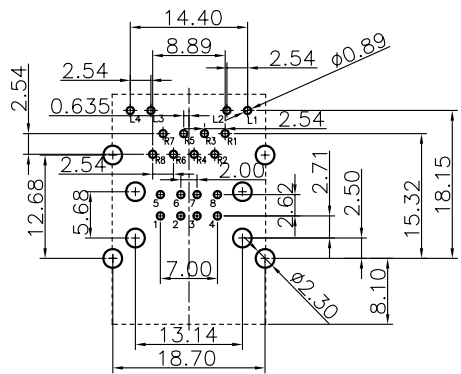

PCB LAYOUT

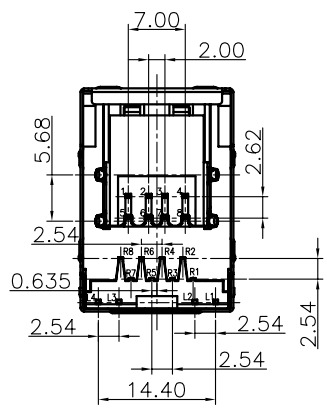

XXXX
月(08)
年(11)
例:
1108
表示:2011年8月

R570-311X0-XXX0XR

LED COLOUR
0:Without,
1:Green/Yellow
2:Yellow/Green
6:Yellow/Green Orange

1:tray
8:Tape&Reel
1:Black
4:Yellow 107C
T:Yellow 114C
P:Blue 285C

2:PBT
3:PA46
5:PA9T
6:LCP

1:Au 1u", 3:Au 3u"
5:Au 5u", 8:Au 15u"
A:Au 30u", B:Au 50u"

| TOLERANCE UNLESS OTHERWISE SPECIFIED | |
|--------------------------------------|---------|
| .XXX ±0.10 | .X ±3' |
| .XX ±0.20 | .XX ±2' |
| .X ±0.30 | |

4YBST 深圳市亿利百斯特电子有限公司
ShenZhen ElyBest Electronics Co., Ltd

| | | | | | | |
|----------|--------------|-------------|--------------------|-------|-------|------|
| APPROVED | | PART NAME: | RJ45+双层USB+LED 带周期 | | | |
| CHECKED | | PART No: | R570-311X0-XXX0XR | C | | |
| DRAWN | pengchaoyong | PROJECTION: | UNIT: | SCALE | SHEET | REV. |
| DATE | 2015.05.26 | | mm | 1:1 | 10F1 | A |